

Model Modification of Participatory of Community Asset Development Research In Action (YUDHIA) for Childbirth and Pregnancy

by Artha Budi Susila Duarsa

Submission date: 01-Dec-2020 10:15PM (UTC+0700)

Submission ID: 1461424975

File name: duarsa_original_conclusion.docx (185.63K)

Word count: 8751

Character count: 49744

Model Modification of Participatory of Community Asset Development Research In Action (YUDHIA) for Childbirth and Pregnancy

Artha Budi Susila Duarsa^{1*}, I Putu Dedy Arjita²

^{1,2} Medical Faculty, Al Azhar Islamic University of Mataram, West Nusa Tenggara, Indonesia

*Corresponding e-mail: duarsaartha@gmail.com

ABSTRACT

Background: Direct maternal deaths are mostly caused by obstetric complications. Several programs have been carried out to reduce the incidence of pregnancy and childbirth complications. However the implementation of the program has not been maximized. Community empowerment is needed to ensure the sustainability of the program. **Objective:** Therefore this study was carried out for Model Modification of Participatory Community Asset Development Research In Action (YUDHIA). **Methods:** This research was conducted with a mixed method approach. The construction model was carried out qualitatively, with forum group discussion and indepth interview toward four key informants and thirteen supporting informants. Then conducting model development quantitatively using a cross-sectional study on 80 respondents, and analyzed by using SEM PLS. After model was formed, the test was implemented to 83 respondents by using pre and posttest design. The application of the YUDHIA Model in the community is carried out by assisting the model using the YUDHIA Module. **Results:** The construction showed that the YUDHIA Model can be constructed by five variables, namely the development of community assets, community participation, knowledge, attitudes and behavior. Then the validation is done and the results are obtained that all the variables are valid in forming the YUDHIA Model. The YUDHIA assistance model is statistically proven to be able to improve knowledge ($p < 0,000$), attitudes ($p < 0,000$) and behavior of the pregnant mothers ($p < 0,000$) compared to before getting assistance. **Conclusion:** The YUDHIA model consists of five forming variables and this model has proven effective in increasing the knowledge, attitudes and behavior of pregnant mothers towards the prevention of pregnancy and childbirth complications.

Keywords: Mother mortality, Pregnancy and Childbirth Complications, YUDHIA Model

INTRODUCTION

Maternal Mortality Rate (MMR) is one important indicator of the degree of public health. The MMR described the number of mothers who died caused by pregnancy disorders or their management (excluding accidents or incidental cases) during pregnancy, childbirth and in the puerperium (42 days after giving birth) regardless of the length of pregnancy per 100,000 live births. The MMR can be used in monitoring deaths related to pregnancy. This indicator is influenced by general health status, education and services during pregnancy and childbirth [1].

The direct cause of more than 90% maternal mortality is the result of obstetric complications, especially childbirth complications. Complication is a difficulties maker, a condition that aggravates a disease. Pregnancy complications are obstetric emergencies that can cause death to both mother and fetus. Pregnancy complications are related to hypertension and preeclampsia, anemia, placenta previa, and diabetes [2]. Meanwhile the childbirth complications is a difficult

childbirth (*dystosia*) that causing a disease. Complications of childbirth include premature rupture of membranes, pre-delivery childbirth, fetal position abnormalities, and others.

Childbirth complications are unpredictable and difficult to find why, so treatment is difficult to apply with certainty. Some factors that can cause high risk childbirth include maternal age, education level, occupation, family income, knowledge of antenatal examinations or *antenatal care* (ANC), maternal attitudes toward ANC examinations, maternal practices during ANC examinations, parity, distance of pregnancy, medical history, obstetric history and quality of ANC care [3] [4] [5] [6].

The government has carried out the Birth Planning and Complications Prevention Program (P4K) as an effort to accelerate the reduction of MMR. This program has been launched by the government since 2007 (Ibrahim, 2008). Through P4K, it is expected that every pregnant woman will be recorded and monitored appropriately. The technical form of P4K is the provision of sticker to every pregnant woman that can be attached to her home [7].

The target to be achieved in P4K begins with monitoring of targets with high, medium, low risk directly in the hope that complications can be prevented and overcome early. In fact, the P4K has not been maximally implemented, only around 55% (Mulyati dan Triani, 2012). This is due to the lack of understanding of pregnant women to conduct early detection of high risk pregnancies, the lack of participation of cadres and health workers (midwives) in socializing P4K and the delivery of information to pregnant women is unclear so that pregnant women do not understand the benefits and objectives of P4K, pregnant women are less received support from her husband and family [8]. The presentation of [9] states that the health problems of pregnant women and infants are not only focused on health workers but also requires community-based partnerships.

One of the strategic steps is to increase knowledge, awareness and motivation towards improving behavior towards efforts to prevent complications of pregnancy and childbirth. This can be done through empowerment activities and family or community participation. Participation is voluntary involvement by the community in self-determined changes; it can also be interpreted as community involvement in the development of themselves, their lives and environment [10].

Participatory Action Research (PAR) is research that actively involves all relevant parties in assessing the actions that are taking place (where their own experience is a problem) in order to make changes and improvements for the better [11] PAR is a process in which researchers and participants work together systematically in exploring and solving problems [12]

Another approach that can be taken in community empowerment is *Asset Based Community Development* (ABCD) or community asset- based development is an approach that is based on local assets contained in an area. These assets were developed so as to solve the problems found in the region. Simply put, the ABCD concept emphasizes the importance of the involvement of individuals, associations and institutions in society to jointly develop their potential (assets). These assets can be in the form of individuals, institutions, associations and organizations [13].

The ABCD approach is a community asset-based development for community building and community capacity building through community exploration and asset maps, emphasizing positive capacity, and community capacity to identify relevant issues; to develop appropriate solutions from community strengths [14]. The strength of the ABCD model is the use of assets and potential, which is owned by the community, to increase the leverage on community change in solving problems.

Based on the strengths of PAR and ABCD, the two methods were modified, namely the assistance¹ model through community empowerment and the use¹ of assets in the community to prevent complications of pregnancy and childbirth called the *Participatory Asset¹Community Development Research In Action (YUDHIA) model*. The YUDHIA Model intended to complement each other and adapt to the needs and situations and conditions of the people involved in this research.

METHODS

Research Type and Design

The study approach used in this study is a mixed method with a sequential explanatory approach strategy whose main focus is on model development. Refer to Morse (1995) in [15]; model development begins with a qualitative approach that aims to explore phenomena. This stage is usually called phase I (model construction). From the findings of phase I, the author made *key decision* to be the focus of phase II (model development). Phase II then carried out quantitatively to develop instruments or tools that will be used in phase III (model trials). At this phase III trials are conducted on selected populations.

Research Location

¹This research was conducted in all village² in Cimanuk Subdistrict, Pandeglang District. Cimanuk Subdistrict consists of 11 villages. Based on a preliminary study conducted by the author, it is known that from 35 sub-districts in Pandeglang District, the proportion of high-risk pregnant women in Cimanuk Subdistrict is the highest.

Population and Samples

²The population in this study was 800 women of *trimester* II and III pregnancy who live in the Health Center (*Puskesmas*) working area of Cimanuk Subdistrict. The number of minimum samples taken by the author directly through the object was 80 respondents with inclusion and exclusion criteria as follows:

1) Inclusion criteria: Pregnant women with healthy conditions, domiciled in the working area of the Cimanuk Subdistrict Health Center, high risk pregnant women, mothers and husbands agreed to be respondents. 2) Exclusion criteria: Pregnant women who have experienced complications, abnormal pregnancy, respondents moved domicile.

The number of samples taken in accordance with the rules of the number of samples in the PLS (*Partial Least Squares*) guidelines where the amount of sample taken is 5 to 10 multiples of the number of indicators to be examined. In this study there are 16 indicators used to observe five variables, so in this case the sample size is ideally between 80 and 150.

Phase I - Model Construction

Phase I is the enrichment stage for the initial development of the YUDHIA model. Conceptually, this YUDHIA model is based on the Innovation Diffusion theory. Community participation and the development of community assets can be applied together and will be able to increase knowledge. With the better knowledge possessed, of course it will manifest a positive attitude towards pregnancy and childbirth complications. Finally, the positive attitude will be implemented in a behavior to prevent pregnancy and childbirth complications.

In phase I, this study offers a fairly comprehensive concept, which combines community participation with the utilization of assets in the community to improve the prevention of pregnancy and childbirth complications. The phase I conceptual framework can be seen in Figure 1 below. As for the YUDHIA Model construction flow is illustrated in Figure 2.

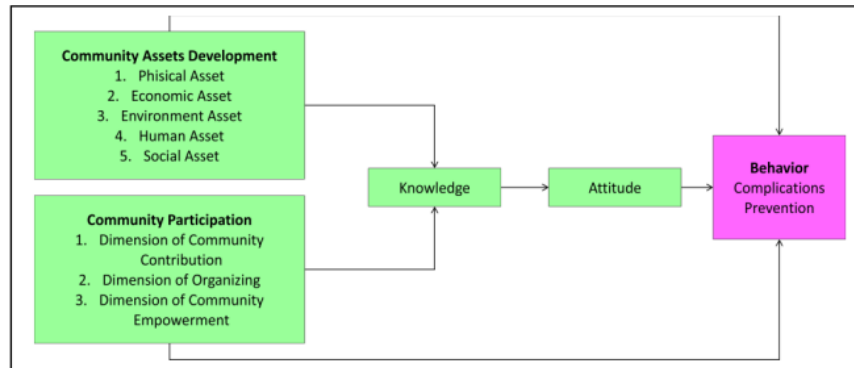

Figure 1. Phase I of YUDHIA Model construction conceptual framework

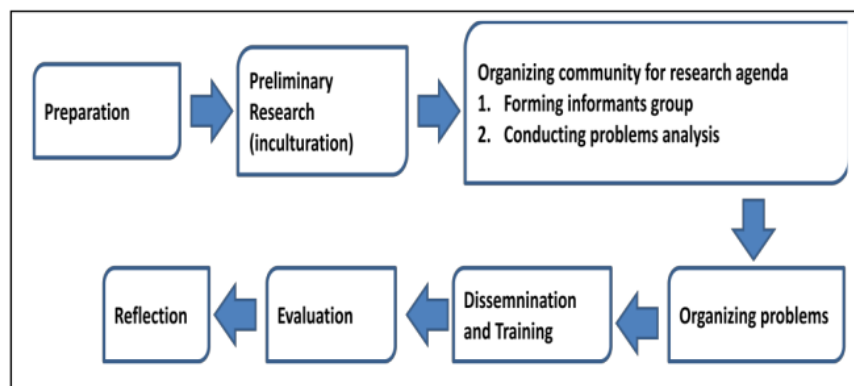

Figure 2. YUDHIA model construction flow

In phase I a qualitative approach was applied using the *Rapid Assessment Procedure (RAP)* strategy because it explores how community participation and the development of community assets in the prevention of pregnancy and childbirth complications in a short time [16]. Qualitative data collection techniques using *Focused Group Discussion (FGD)* [17] and [18], *Indepth Interview* and observation. To ensure the validation of qualitative results, triangulation is carried out, so as to increase confidence in the answers given. Triangulation is a process in highlighting a phenomenon/topic from various points of view so that it can provide a comprehensive answer. In the end the results of the study can provide credible and responsible conclusions [18].

In phase I, based on Figure 2, there were 4 people who served as key informants and 13 as supporting informants in the data collection process. The data that has been collected is then coded. The coding process aims to describe the settings, people, categories and themes to be analyzed [19]. Then descriptions of the themes obtained (theme analysis) were carried out. Themes analysis is a set of procedures that holistically understands the views being studied [20].

The analysis process begins with the assembly of raw materials and taking an in-depth review or a total picture of the whole process. Analysis is the process of sorting data, organizing data into basic descriptive patterns, categories and units. Data reduction strategy is very important in this case [20]. The final step is to interpret data [19] which involves binding meaning and significance to analysis, explaining descriptive patterns, looking at relationships and linkages between descriptive dimensions [20].

Phase II - Model Development

The development of the phase II concept framework is inseparable from the phase I model, which contains a framework for thinking about the effect of developing community assets and community participation, knowledge and attitudes of pregnant women and their impact on the behavior of preventing pregnancy and childbirth complications. The development of community assets in question is related to health services, planners and finances, the distance from home to health facilities, human factors and the social status of pregnant women in relation to knowledge. In phase II, it will be described the related model, the development of community assets and community participation are considered as a stimulus, knowledge and attitudes are considered as organisms and behavior is output that is considered as a response / reaction of pregnant women to input factors. The development of this phase II conceptual framework is shown in Figure 2 and Figure 3 respectively.

The model phase II conceptual framework was developed with a quantitative approach in the form of a cross-sectional study design. Cross-sectional design can describe the conditions of behavior, knowledge, attitudes, community participation and the development of community assets at the time of observation [21] and see if the variables formed based on the results of phase I have a significant relationship with the behavior of preventing pregnancy and childbirth complications. The number of respondents in phase II was 80 respondents. Furthermore, the analysis used is the *Partial Least Square Model in Structural Equation Modeling (SEM)* technique or known as SEM PLS.

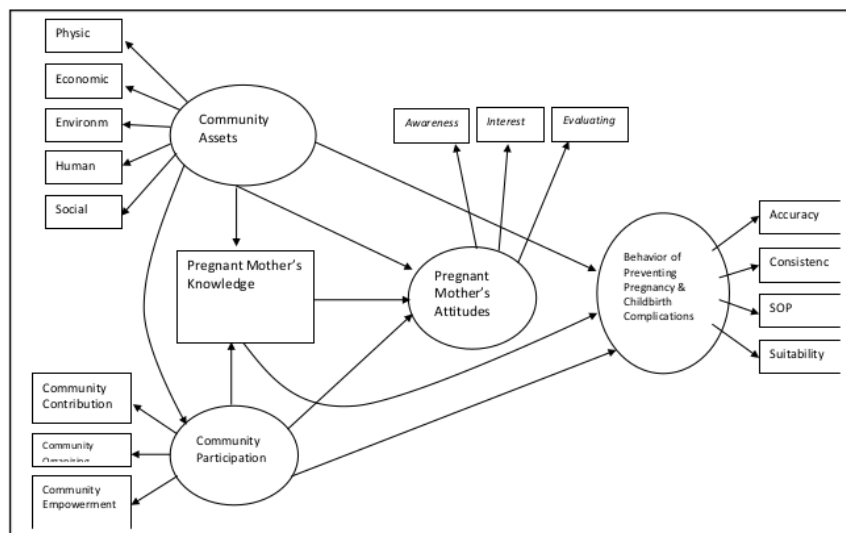

Figure 2. Conceptual Framework for Equation Model

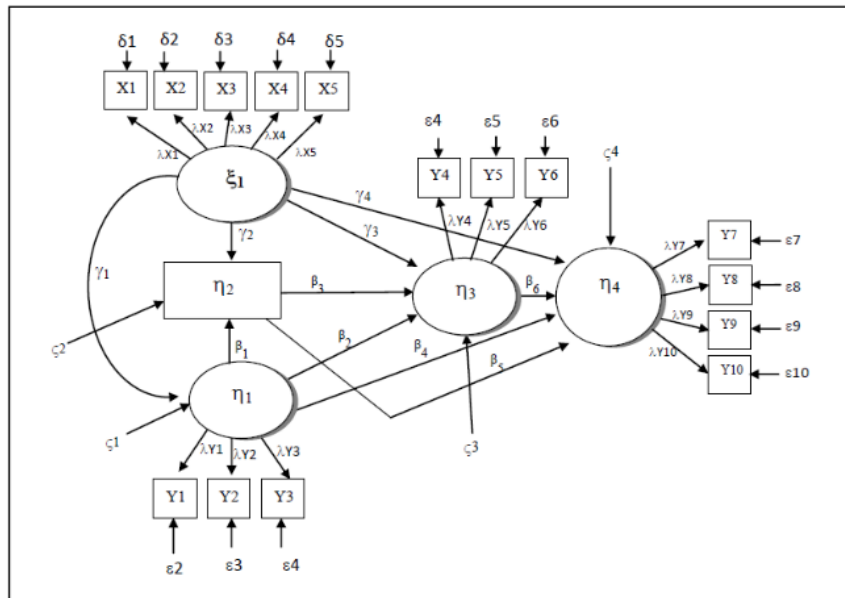

Figure 3. Analysis Framework with Structural Equation Model

The mathematical model for the PLS figure above is:

$$\eta_1 = \xi_1 \gamma_1 + \zeta_1 \dots\dots\dots (1)$$

Equation 1 states the effect of community development on community participation. In the conceptual framework, community development will be symbolized as ξ (Exogenous), community participation is symbolized as η_1 (Endogenous 1) and other factor not examined are symbolized as ζ_1 .

$$\eta_2 = \xi_1 \gamma_2 + \beta_1. \eta_1 + \zeta_2 \dots\dots\dots (2)$$

Equation 2 states the effect of developing community assets and community participation on knowledge. In the conceptual framework, the development of community assets will be symbolized as ξ (Exogenous), community participation is symbolized as η_1 (Endogenous 1), knowledge is symbolized as η_2 (Endogenous 2) and other factor not examined are symbolized as ζ_2 .

$$\eta_3 = \beta_2. \eta_1 + \beta_3. \eta_2 + \gamma_3 \xi_1 + \zeta_3 \dots\dots\dots (3)$$

Equation 3 states the effect of developing community assets, community participation and knowledge on attitudes. In the conceptual framework, the development of community assets will be symbolized as ξ (Exogenous), community participation is symbolized as η_1 (Endogenous 1), knowledge is symbolized as η_2 (Endogenous 2), attitude is symbolized as η_3 (Endogenous 3) and other factor not examined are symbolized as ζ_3 .

$$\eta_4 = \beta_4. \eta_1 + \beta_5. \eta_2 + \beta_6. \eta_3 + \gamma_4 \xi_1 + \zeta_4 \dots\dots\dots (4)$$

Equation 4 states the effect of community development assets, community participation, knowledge and attitudes towards behavior. In the conceptual framework, the development of community assets will be symbolized as ξ (Exogenous), community participation is symbolized as η_1 (Endogenous 1), knowledge is symbolized as η_2 (Endogenous 2), attitude is symbolized as

η_3 (Endogenous 3), behavior is symbolized as η_4 (Pure Endogenous) and other factor not examined are symbolized as ζ_4 .

Phase III – Model Evaluation

The next phase is to test the model in a limited population, by providing assistance in applying the YUDHIA Model. It is at this time of assistance that the participation and utilization of community assets that have been developed are very much needed. The YUDHIA Model evaluation concept is shown in Figure 4 below.

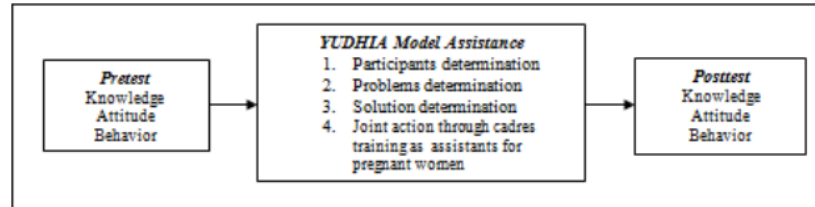

Figure 4 YUDHIA Model evaluation concept framework

In general, at this phase III the pre and posttest study designs are applied to evaluate effectiveness [22] of YUDHIA Model assisting interventions to change knowledge, attitudes and behaviors to prevent pregnancy and childbirth complications. More detailed, prior to assistance, a pretest is conducted to provide an initial description of the knowledge, attitudes and behavior of pregnant women related to pregnancy and childbirth complications. Furthermore, pregnant women get assistance. In this assistance process, participants are determined by consultation to assist pregnant women. Then the assistants identify the problems faced by pregnant women and make an effort to find a solution by utilizing all the assets in the community. The final step is to take action in the form of mentoring training for pregnant women. The assistance process is carried out for 3-6 months until the mother gives birth. Then a post-test is conducted to measure the effectiveness of assistance to changes in knowledge, attitudes and behavior. The number of respondents in this phase III was 83 respondents.

RESULTS

Result of Phase I: Model YUDHIA Construction

- Key Informants Characteristics

The characteristics data of the informants were obtained from documents owned by the informants and based on the results of field observations. The number of key informants used was 4 people. Key informants used as subjects are pregnant women who are at risk of complications of pregnancy and childbirth. The age range of key informants' reproduction ranges from 26-34 years. More details are shown in Table 1.

Table 1. Key Informants Characteristics

Initials	Age	Nmbr of Children	Occupation	Education	Gestational Age	Distnce to Health Ctre
S1	32	3 chldrn	Housewife	Primary Sc	8 months	3 km
S2	28	1 chld	Housewife	Primary Sc	6 months	7 km
S3	26	2 chldrn	Housewife	High School	6 months	2 km
S4	34	2 chldrn	Laborer	Junior High Sc	5 months	6 km

- Supporting Informants Characteristics

Supporting informants were obtained from community leaders, heads of *puskesmas* (health center) or experts, health workers (midwives), health cadres, husbands / families and shamans / *paraji*. There were a total of 13 people who were used as supporting informants. More detailed information about supporting informants is presented in Table 2.

Table 2. Supporting Informants Characteristics

Initials	Age	Position	Years of Service	Work Unit	Education
KP	48	Head of <i>Puskesmas</i>	20 years	<i>Puskesmas</i> of Cimanuk Subdistrict	General Practitioner
Bd1	40	<i>Puskesmas</i> Midwives Coordinator	15 years	<i>Puskesmas</i> of Cimanuk Subdistrict	Dipl.IV of Midwifery
Bd2	36	<i>Puskesmas</i> Midwife	10 years	<i>Puskesmas</i> of Cimanuk Subdistrict	Dipl.III of Midwifery
Bds	29	Village Midwife	4 years	<i>Puskesmas</i> of Cimanuk Subdistrict	Dipl.III of Midwifery
Bds	28	Village Midwife	5 years	<i>Puskesmas</i> of Cimanuk Subdistrict	Dipl.IV of Midwifery
Kd1	40	Health Cadre	10 years	Cimanuk Subdistrict	Junior H.Sc
Kd2	36	Health Cadre	8 years	Cimanuk Subdistrict	Primary Sc
Kd3	32	Health Cadre	5 years	Cimanuk Subdistrict	Junior H.Sc
Kds1	34	Village Head	2 years	Cimanuk Subdistrict	HighSc
Kds2	45	Village Secretary	3 years	Cimanuk Subdistrict	Bachelor
SM	40	Head of Household	4 years	Laborer	HighSc
DK1	52	Village Shaman	20 years	Cimanuk Subdistrict	Tidak Sekolah
DK2	58	Village Shaman	30 years	Cimanuk Subdistrict	Not completed Primary Sc

Result of Phase II: YUDHIA Model Development

- Model Structural

The model structural result is shown in the following Figure 5.

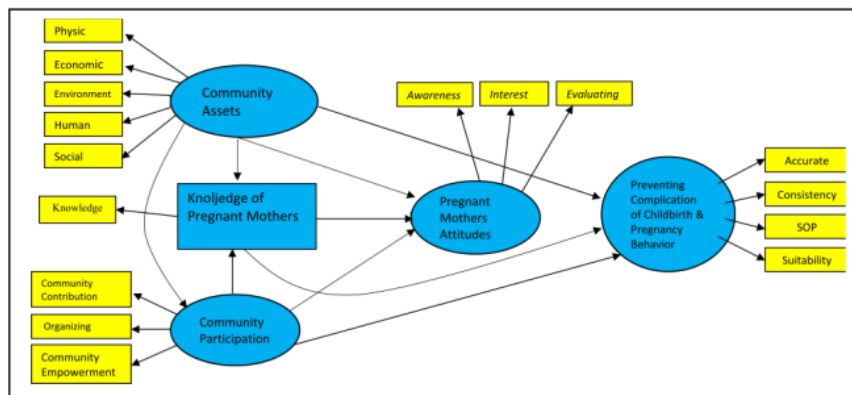

Figure 5. YUDHIA Model Structural with SEM PLS

- Validity Test per Indicator

This phase is carried out to determine whether there is a relationship between variables and the relationship between endogenous and exogenous variables. The description of this *factor loading* according to the model structural formed. Variables that have *factor loading* > 0,5 indicates a relationship with other variables.

The results of data analysis show that the construct used to form a research model. In the confirmatory factor analysis process, the criteria have been set. The probability value in this

analysis shows a value above the significance limit of 0.5. From the results of data processing it can also be seen that each indicator or dimension forming latent variables shows good results, with a high loading factor value where each indicator is greater than 0.5. With this result it can be said that the indicators forming latent variables of community participation, knowledge and attitudes have shown good results.

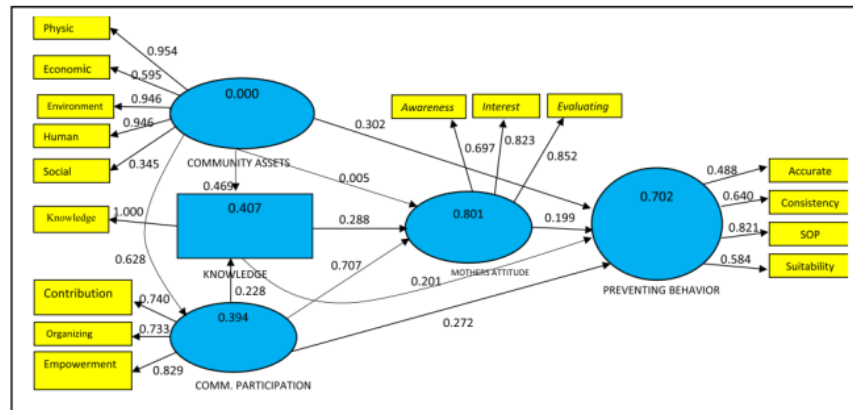

Figure 6. Factor Loading of YUDHIA Model

The table below shows the results of the validity test of each indicator in forming variables.

Table 3. Validity Test of Indicators of Community Asset, Community Participation, Knowledge, Attitudes and Behavior of P4K Prevention by Evaluating Outer Loading Values (Convergent Validity)

Validity	Influence	Test Result	Test Criteria > 0,5
Outer Loading (Convergent Validity)	Physic	0.954282	Valid
	Economic	0.59548	Valid
	Environment	0.945715	Valid
	Human	0.945715	Valid
	Social	0.345203	Not Valid
	Contribution	0.739831	Valid
	Organizing	0.733112	Valid
	Empowerment	0.829096	Valid
	Knowledge	1	Valid
		Awareness	0.697422
Interest		0.822984	Valid
Evaluation		0.851856	Valid
Accurate		0.487694	Not Valid
Consistent		0.639951	Valid
SOP		0.821297	Valid
Suitability		0.584276	Valid

The results above show that most indicators are valid for forming variables. However, there are two constructs, namely the social construct on the community assets variable and the accuracy construct on the behavior of prevention of pregnancy and childbirth complications variable are still smaller than 0.5. This means that the constructs are not valid so that both constructs are removed from the model.

Another method to test the *discriminant validity* is through the values of *Square root of average variance extracted (AVE)*. The expected value is above 0,50.

Table 4. Validity Test of the Variables of Community Assets, Community Participation, Knowledge, Attitudes and Behavior in Prevention of P4K by Evaluating the Value of AVE (Average Variance Extracted)

Variable	AVE	Test Criteria > 0,5
Community Assets	0.634634	Valid
Community Participation	0.590735	Valid
Knowledge	1	Valid
Pregnant Mothers Attitude	0.629786	Valid
Prevention Behavior	0.519435	Valid

From the table above it can be seen that all variables are declared valid because they provide AVE values above 0.5. So it can be concluded that the evaluation of model measurements has good discriminate validity or valid.

- **Reliability Test**

The reliability test is done by looking at the composite reliability value of the indicator block measuring the construct of composite reliability results will show a satisfactory value if above 0.70. The results of evaluating the reliability of the outer model can be seen in the table by evaluating the value of Cronbach's Alpha and composite reliability.

Table 5. Reliability Test of Variables of Community Asset, Community Participation, Knowledge, Attitudes and Behavior in Prevention of Pregnancy and Childbirth Complications by Evaluating Values in the Outer Model

Reliability Test	Test Result		Test Criteria > 0,70
	Influence	Loading	
Composite reliability	Community Assets	0,886979	Reliable
	Community Participation	0,811895	Reliable
	Knowledge	1	Reliable
	Pregnant Mothers Attitude	0,835174	Reliable
	Prevention Behavior	0,733066	Reliable

- **R-Square Value**

Testing of structural model is done by looking at *r-square* which is the test of *Goodness-fit* model. The following is the measurement result of the *r-square* value, which is also the *goodness-fit* model value.

Table 6. Evaluation of R-Square value of Models of the Community Assets, Community Participation, Knowledge, Attitudes and Behavior in Prevention of Pregnancy and Childbirth Complications

Test Result	
Variable	R Square
Community Assets	
Community Participation	0,393903
Knowledge	0,407059

Pregnant Mothers Attitude	0,801326
Prevention Behavior	0,70228

From the above table, it can be seen that the *r-square* value on the variable of prevention of pregnancy and childbirth complications is 70.2% and the remaining 39.8% is influenced by other factors. The *r-square* value on the community participation variable was 39.4% and the remaining 60.6% was influenced by other factors. The *r-square* value on the knowledge variable of pregnant women is 40.7% and the remaining 59.3% is influenced by other factors. *R-square* value on the variable of attitude of pregnant women is 80.1% and the remaining 19.9% is influenced by other factors.

• T-Statistik Value

The figure below is a statistical T model from the YUDHIA model. Statistical T value indicates the significance of a relationship. Statistical T value > 1.96 indicates a significant relationship.

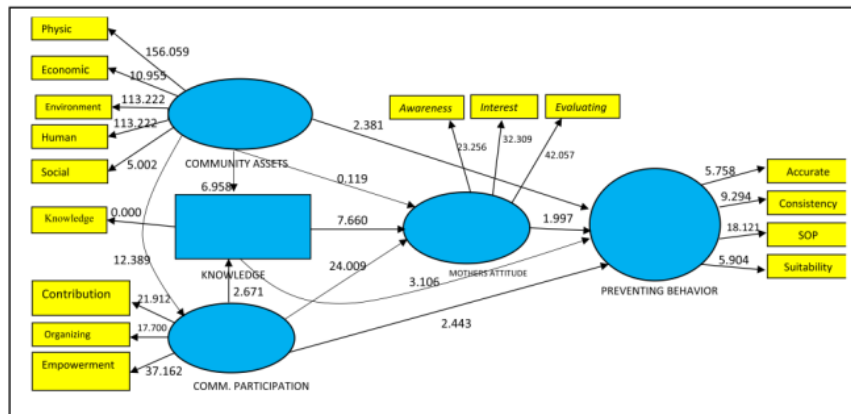

Figure 7. T Statistik of YUDHIA Model

The results of evaluating the significance of the inner model are set out in the Smart PLS output below by evaluating the reflection of the T statistic value of the indicator on the variable.

Table 7. Evaluation of Reflection on the T Statistics Value of on the Indicators of Each Variable

Significance Test	Indicators	T-statistics	Reflection > 1.96
T Statistics	Physic	156,0588	Significant
	Economic	10,95459	Significant
	Environment	113,2217	Significant
	Human	113,2217	Significant
	Social	5,001652	Significant
	Contribution	21,91151	Significant
	Organizing	17,6997	Significant
	Empowerment	37,16224	Significant
	Awareness	23,25582	Significant
	Interest	32,30943	Significant
	Evaluation	42,05666	Significant
	Accurate	5,758334	Significant

	Consistent	9,294224	Significant
	SOP	18,12111	Significant
	Suitability	5,903931	Significant

From the above table, it states that the T statistics value reflected on the variable is mostly > 1.96; it shows the indicator block has a positive and significant effect to reflect the variable.

Table 8. Reflection Evaluation of Exogenous Variable T Statistics Value on Endogenous Variable

Test of Significance	Influence between Variables	T Statistics	Conclusion	
	Exogenous	Endogenous		
T Statistics Test	Community Assets	Behavior of Preventing Complications of Pregnancy and Childbirth	2.380697	There is influence and significant
	Community Participation	Behavior of Preventing Complications of Pregnancy and Childbirth	2.442641	There is influence and significant
	Knowledge of Pregnant Mothers	Behavior of Preventing Complications of Pregnancy and Childbirth	3.106069	There is influence and significant
	Pregnant Mothers Attitude	Behavior of Preventing Complications of Pregnancy and Childbirth	1.996976	There is influence and significant

The test results of the parameter coefficient between knowledge of pregnant women on behavior of preventing complications of pregnancy and childbirth in the Cimanuk sub-district showed a positive and significant effect of 3,10 in $\alpha=5\%$. The same thing was followed by community participation in the prevention of complications of pregnancy and childbirth in the Cimanuk sub-district has a positive and significant effect of 2.44 in $\alpha=5\%$. The T statistics value is far above the critical value (1,96).

Effect of Assistance Implementation of Participatory Community Asset Development Research In Action (YUDHIA) on the Knowledge, Attitudes and Behavior of Respondents

At this phase an evaluation of the YUDHIA Model assistance was carried out on changes in respondents' knowledge, attitudes and behavior regarding the prevention of complications of pregnancy and childbirth. Scores of respondents' knowledge variables about the prevention of pregnancy and childbirth complications are presented in the following Table 9.

Table 9. Scores Distribution of Knowledge of Pregnant Women Before and After the YUDHIA Model Assistance Training

Variable	N	Mean	Median	SD	Min-Max
Pre	83	41,01	50	10,17	29-61

Post	83	70,72	82	12,06	55-82
Score difference		29,71			

The analysis results of the knowledge of pregnant women following the YUDHIA Model assistance obtained the average knowledge of pregnant women in the first measurement of 41.01 with a standard deviation of 10.17, a minimum value of 29 and a maximum of 63. Meanwhile in the second measurement the average knowledge of pregnant women is 70, 72 with a standard deviation of 12.06, a minimum value of 55 and a maximum of 82. There was an increase in the knowledge score of respondents before and after mentoring the YUDHIA model assistance of 29.71.

Scores change in respondents' attitude before and after YUDHIA model assistance are shown in Table 10. The average attitude of pregnant women in the first measurement was 36.05 with a standard deviation of 9.49, a minimum value of 17 and a maximum of 70. While in the second measurement the average attitude of pregnant women were 69.16 with a standard deviation of 5.10, the value of minimum 50 and maximum 80. There was an increase score in the attitude of respondents before and after the YUDHIA model assistance by 33.11.

Table 10. Scores Distribution of Attitude of Pregnant Women Before and After the YUDHIA Model Assistance Training

Variable	N	Mean	Median	SD	Min-Max
Pre	83	36,05	34	9,49	17 – 70
Post	83	69,16	68	5,10	50 – 80
Score difference		33,11			

These results indicate that pregnant women in Cimanuk sub-district still have a bad attitude in preventing complications of pregnancy and childbirth. The increase scores in attitude that occur after YUDHIA model assistance is able to improve attitude scores meaning it is necessary to carry out continuous assistance so that the attitude of pregnant women towards the prevention of complications of pregnancy and childbirth becomes better.

The description of changes in the score of pregnant mothers' behavior related to the prevention of complications of pregnancy and childbirth is shown in Table 11. The results of the analysis of the behavior of pregnant women following the YUDHIA model showed the average behavior of pregnant women at the first measurement (before assistance) was 34.75 with a standard deviation of 12, 04, a minimum value of 18 and a maximum of 54. While in the second measurement it is found that the average behavior of pregnant women (after assistance) was 78.19 with a standard deviation of 7.01, a minimum value of 55 and a maximum of 110. There was an increase scores in the behavior of respondents before and after YUDHIA model assistance was 33.44.

The data above shows that the behavior of preventing complications of pregnancy and childbirth has been carried out by pregnant women although it is still very limited (which is indicated by the low knowledge score). The YUDHIA Model assistance program is able to improve the prevention of pregnancy and childbirth complications.

Table 11. Scores Distribution of Behavior of Pregnant Women Before and After the YUDHIA Model Assistance Training

Variable	N	Mean	Median	SD	Min-Max
Pre	83	44,75	52	12,04	18-54
Post	83	78,19	75	7,01	55-110
Score difference		33,44			

The analysis results of the changes in knowledge, attitudes and behavior of pregnant women before and after the YUDHIA model assistance can be seen in Table 12. The proportion of the influence of the YUDHIA Model assistance on the knowledge, attitude and behavior of pregnant women before and after the assistance was statistically obtained $P < 0.05$. It can be concluded that there are significant differences between the knowledge, attitudes and behavior of pregnant women before and after the YUDHIA model assistance in the work area of Pandeglang District.

The interpretation of these findings is that the YUDHIA model assistance is effective enough to improve the knowledge, attitudes and behavior of pregnant women in preventing complications of pregnancy and childbirth. The YUDHIA model assistance needs to be carried out on an ongoing basis to maintain a consistent behavior in preventing complications of pregnancy and childbirth.

Table 12. Analysis of Changes in Knowledge, Attitudes and Behavior of Pregnant Women Before and After YUDHIA Model Assistance Training

Variable	n	P-value	Conclusion
Knowledge	83	0,000	Significant
Attitudes	83	0,000	Significant
Behavior	83	0,000	Significant

DISCUSSION

YUDHIA Model Construction

Conceptually, the construction of the YUDHIA model involves community participation consisting of community contributions, organizing, community empowerment and the utilization of potential (assets) in the community, which consists of various types, namely physical, social, economic, environmental and human assets. The results of the FGD showed the community participation in efforts to prevent complications of pregnancy and childbirth, in the form of mutual cooperation, routine meetings of pregnant women and the socialization of pregnancy myths. And the assets that play a role in community participation to prevent complications of childbirth and pregnancy are physical assets, human assets, social assets, environmental assets and economic assets.

YUDHIA Model Development

The YUDHIA model is a valid model for preventing the occurrence of complications of pregnancy and childbirth. This is seen from the results of SEM analysis which shows that all exogenous variables have an influence on the behavior of preventing pregnancy and childbirth complications (endogenous). It can be said that the variable assets, community participation, knowledge and attitudes are things that must be met in realizing the behavior of the prevention of pregnancy and childbirth complications.

From the analysis it is known that of the five assets tested (physical, human, social,

environmental and economic), only social assets are invalid in forming the community asset variable. Social assets in this study are the positions and awards received by mothers in their families, including in making decisions related to maternal health. The observation of researchers can be seen that all the wives in this study are in the same position (homogeneous), which is less able to play a role in making decisions about maternal health they experience. A study conducted in Cianjur, West Java shows that in fact a wife can play a role in making decisions together with her husband about maternal health in a family with sufficient socioeconomic conditions, has health insurance, the family has knowledge of signs of complications, the severity of the disease and the cause of illness sufficiently well [23].

The results of the analysis show that community participation has a direct relationship with the behavior of preventing complications of pregnancy and childbirth. These results are in accordance with studies conducted in Nepal [24] and India [25]. Both studies involve community participation in communication / discussion with health service providers, identifying problems, planning action and monitoring actions. With community involvement, activities to prevent complications of pregnancy and childbirth have increased. Examples include increased ANC visits, increased deliveries in trained health workers, and increased hand washing behavior of the midwives.

Refer to the Alma Ata Declaration that community participation is a principle and comprehensive basic health service and according to the Ottawa Charter is an important feature in health promotion. Described as individual participation in clinical decision making, mobilizing resources in the community towards health care, as well as collective participation in health service planning and implementation. Given the wide scope of community participation, so the implementation of community participation in health services also varies greatly [26].

Community participation that can be done is to encourage the community to think and convey problems and services and actions about maternal health and then help take action on what is explained [27]. Associated with efforts to prevent complications of pregnancy and childbirth, the presence of community participation is expected to be able to do "autodiagnosis" to the problems of pregnancy and childbirth that arise in the vicinity. So that every community group involved must gain knowledge about reproductive health, signs and symptoms that are harmful to pregnancy and childbirth, appropriate baby services and an increasing number of women who have access to trained health workers [28]. Community participation in maternal health in an area is also strongly influenced by political, economic, socio-cultural and environmental characteristics in the area where the community lives [29].

Knowledge also has a significant direct relationship with complications prevention behavior. Studies conducted in Tanzania show similar results. In areas that are active in promoting pregnancy and healthy deliveries, the rate of births in health workers is higher than that at home with the help of traditional birth attendants [30]. It must be realized that the mother's knowledge about the symptoms and signs of childbirth complications is still very limited. This study shows that 50 percent of respondents have good knowledge about the signs and symptoms of complications of pregnancy and childbirth. These results are in line with the findings of a study in Ethiopia which said there were about 35.1% and 31.8% of mothers who did not know the signs of complications of pregnancy and childbirth [31].

This study shows that attitude has a significant relationship with the behavior of preventing complications of pregnancy and childbirth, where 50 percent of respondents have a good attitude

about the prevention of complications of pregnancy and childbirth. The high percentage of positive attitudes found in some countries such as Egypt [7] and Malaysia [32]. But studies in both countries show that attitude has no meaningful relationship with behavior. This can be caused by differences in methods in sampling and collecting data.

Knowledge and attitude studies are generally used throughout the world in designing health promotion programs and intervention programs that impact knowledge and enhance attitudes and behaviors that pose risks to health.

The attitude of pregnant women and families determines decision making in an effort to save pregnant women giving birth and the postpartum period. This can be done by increasing knowledge through childbirth planning programs and prevention of complications so as to increase the role of husband, family and community in dealing with labor and complications that may occur, by making agreements between pregnant women, husbands or families with midwives about childbirth assistance, transportation, delivery costs, prospective donor donors blood and postpartum birth control plans.

Whereas the attitude of midwives and cadres is very positive and supports the implementation of childbirth planning programs and prevention of complications. They said that this program was very good and was very useful in accelerating the decline in MMR. However, good knowledge and attitudes have not been supported by behavior that is in accordance with the implementation guidelines. Midwives should facilitate pregnant women and their husbands or families in discussing the components of the birth planning program and prevention of complications until finding an agreement while the cadre helps to collect data and monitor pregnant women in their area. The behavior of midwives who are less supportive is caused by their underperformance, by applying stickers to pregnant women who visit the puskesmas only and those who do antenatal care, are carried out only at the beginning of the program and there are those without going down to the home of pregnant women. Even if it comes down only to pregnant women whose homes are near the health center or midwife.

The Effect of YUDHIA Model

- Effect of the YUDHIA Model on Knowledge, Attitudes and Behavior in Prevention of Complications

The YUDHIA model is carried out by involving health workers (midwives), families, cadres and the community. All elements that play a role need to get training to better understand the concepts and roles in implementing this YUDHIA model. In addition, training is also given to equalize a common goal, namely the formation of behavior to prevent complications of pregnancy and childbirth that can ultimately prevent complications of pregnancy and childbirth. The involvement of cadres and communities in this model is very appropriate. Based on the results of a systematic study, cadres were proven able to convey messages of prevention interventions for maternal and child health problems in developing countries and poor countries. Because cadres are able to deliver messages directly to the target sasaram, namely the mother, by using cultural approaches and habits that apply in the community [33].

- Effect of the YUDHIA Model on Knowledge of Prevention of Pregnancy and Childbirth Complications

This study shows that the application of the YUDHIA model significantly changes the level of maternal knowledge about complications of pregnancy and childbirth. This result is in line with

studies conducted in the UK, that significantly increases midwife knowledge in midwives receiving obstetric emergency training [34].

When the pre-test is done, the average knowledge score of the respondent is only 41,01 (SD 10,17). This score falls into the low knowledge category, meaning that less than 50% of the knowledge about pregnancy and childbirth complications is known by respondents. Knowledge about bleeding is the most widely known by respondents. Studies conducted in Uganda show results that are not much different. Only one-third of respondents know at least three danger signs in the pregnancy, labor and postpartum phases. Among them most of the respondents answered bleeding during pregnancy and swelling of the hands and face was a danger sign during pregnancy [35].

Knowing the signs and symptoms of pregnancy and childbirth complications will make the respondent make greater anticipation and prevention to mitigate the impact of pregnancy and childbirth complications by reducing the first two late and third late if the health facility is ready to handle complications [35]. Recognition of obstetric danger signs is the main key in seeking health services for obstetric emergencies and in seeking prevention or promotion efforts during pregnancy and childbirth. So the lack of awareness of danger signs will be related to the lack of preparation for normal childbirth and preparedness in the face of complications [36] Assuming that all pregnancies have risks, mothers must be aware of the danger signs of pregnancy, childbirth complications and *postpartum*.

Efforts to increase this knowledge can be done by health promotion, both orally, in writing and audio. One of the newest approaches in increasing knowledge and outcome of childbirth is *Centering Parenting* [37]. *Centering Parenting* is a model that involves a group of 6-7 mother-babies together to get care during the first year. Through nine sessions, medical staff provide care and also provide information about health, baby development and issues of maternal and infant safety. The program integrates three main components of care, namely health assessment, education and support in groups [37].

- Effect of the YUDHIA Model on Attitudes of Complications Prevention

This study shows that mentoring the YUDHIA Model significantly increases the attitude scores of pregnant women towards the behavior of preventing complications of pregnancy and childbirth. The attitude changes observed in this study were more common in items about antenatal care. Research in Jordan shows that there are as many as 91% of respondents who have a positive attitude to conduct a pregnancy check at the onset of danger signs of pregnancy [38]. Unfortunately this study did not observe respondents' attitudes toward the danger signs of pregnancy. Though based on studies conducted in Gambia [39] and in Argentina [40] shows that only 30% of pregnant women have a positive attitude related to conditions of mild bleeding, dizziness and vomiting. The rest assume that these signs are normal (negative attitude), as conveyed by the family and the environment around pregnant women. With a positive attitude towards danger signs of pregnancy will trigger positive behavior in pregnancy checks and prevention of complications.

One of the factors that influence the respondent's attitude towards complications of pregnancy and childbirth is the factor of maternal education, husband's education and education from health workers [38]. These three factors can increase awareness about danger signs of pregnancy more than 2 times. This shows that the more exposure to information about complications, the more attitudes will increase so that it gives influence in decision making during pregnancy and

childbirth [41]. Education of the husband is also important because it will be related to the level of support and assistance offered to the wife [42]. While information / promotion about pregnancy complications and childbirth to pregnant women provided by health workers will greatly affect the attitude of mothers. Furthermore, this attitude will affect the behavior of antenatal care. This will be very important in detecting pregnancy complications and giving advice to pregnant women and families about timely follow-up examinations [43].

The implementation of YUDHIA Model assistance to pregnant women is one of them with intensive counseling activities for several days. This activity is a type of health education as explained in the previous paragraph. Counseling material provided is related to antenatal care, pregnancy danger signs, pregnancy care, childbirth and puerperium. From this activity, the mother's knowledge is increasing which is then accompanied by an increase in attitude. Attitude is a reaction or respondent that is still closed from someone to a stimulus, so that the attitude cannot be seen immediately. Obviously attitude shows the appropriateness of reactions to certain stimuli which in everyday life are emotional reactions [44].

- Effect of the YUDHIA Model on Behavior of Complications Prevention

After the YUDHIA Model assistance, there is a significant change in behavior of preventing pregnancy and childbirth complications. The results of this study are in line with the research in Garut, West Java that after receiving the P4K training, childbirth behavior is carried out in health workers.

The YUDHIA model assistance is conducted intensively for 3-6 months until the mother gives birth. In this assistance process, pregnant women receive continuous education and reinforcement from cadres on signs of pregnancy complications and prevention efforts. In addition, promotion of childbirth in health workers continues. This is able to increase respondents' knowledge about complications and ultimately change their behavior, one of which is giving birth at a midwife. In terms of access, the community in Cimanuk sub-district has the financial capacity to deliver in health workers. Although there are some who are not able to, but this can be overcome by the existence of maternity savings. In addition, with the availability of a waiting house, pregnant women in the villages farthest from the health center can wait in the waiting house that has been provided.

The health promotion during the mentoring process increases the knowledge of pregnant women. Knowledge is the basis for maternity to take precautions to prevent complications of pregnancy and childbirth, such as a regular ANC, consuming nutritious food and giving birth with health workers. A person's actions in dealing with a problem reflect the person level of knowledge, where that person can comprehend the problem comprehensively and interpret it correctly. And also able to analyze and evaluate. With the ability of knowledge someone will be able to take better action [4].

CONCLUSION

The YUDHIA model construction is the result of developing community assets, community participation, knowledge, attitudes and behavior. The results of the model construction state that each of these variables has a significant role in realizing the behavior to prevent complications of pregnancy and childbirth. In the community asset development variable, human assets are the most important asset for realizing the behavior to prevent complications of pregnancy and childbirth. Human assets consisting of cadres and *paraji* those are assets that need the most

attention. Increasing knowledge of cadres and *paraji* about pregnancy and childbirth complications, and increasing the ability of cadres to promote to the community are important things to increase public knowledge and awareness in recognizing and dealing with signs of obstetric emergencies. In addition, based on the findings of this study, it is also known that the development of physical assets and the availability of complete equipment and materials have a considerable impact in preventing pregnancy and childbirth complications.

Furthermore, the results of the YUDHIA model development stage II show that all variables have a significant relationship with the behavior to prevent complications of pregnancy and childbirth. This means that efforts to prevent complications of pregnancy and childbirth can be carried out by jointly utilizing existing assets in the community (physical, human, economic, and environment), involving community participation, and increasing community knowledge and attitudes towards prevention of pregnancy and childbirth complications.

The YUDHIA model is applied through a process of mentoring pregnant women by cadres. The YUDHIA model assistance was able to significantly increase the score of knowledge, attitudes and behavior in preventing complications of pregnancy and childbirth. This means that the assistance process in implementing the YUDHIA model is effective in preventing complications of pregnancy and childbirth. By getting assistance, knowledge, attitudes and behavior of pregnant women about the prevention of complications of pregnancy and childbirth can be improved, and finally the incidence of pregnancy and childbirth complications would be prevented.

References

- [1] Ministry of Health of Republic of Indonesia. (2013). Hasil Riset Kesehatan Dasar Tahun 2013. Health Development Research Agency.
- [2] Gong J Savitz, DA, Stein CR, Engel SM. 2012. Maternal ethnicity and pre-eclampsia in New York City, 1995-2003. *Paediatr Perinat Epidemiol*, 26:45-52.
- [3] Fajrin, IN. (2009). Faktor-Faktor Yang Berhubungan Dengan kejadian Komplikasi Persalinan di Rumah Sakit Roemani Semarang Tahun 2008. Skripsi Universitas Semarang
- [4] Notoatmodjo, S. (2003) Metodologi Penelitian Kesehatan. Rineka Cipta. Jakarta
- [5] Retnowati, Indah & Asih Dwi Astuti. (2006) Hubungan Program penerapan Perencanaan Persalinan dan Pencegahan Komplikasi (P4K) oleh Ibu Hamil dengan Upaya Pencegahan Komplikasi kehamilan di Puskesmas Sidorejo Kidul Salatiga. Thesis from Diponegoro University
- [6] Rintawati, Sri Astuti. (2006) Faktor-Faktor yang Berhubungan dengan Kejadian Komplikasi Persalinan Ibu Primipara di RSUD Permata Bunda Purwodadi 2004-2005. Thesis from Diponegoro University
- [7] Ibrahim, S. 2008. Kesehatan Ibu dan Anak Dalam Rangka Menurunkan AKI AKB. <http://dinkes-kutaikartanegara.org.id> (Accessed Januari 4, 2015 at 15.50. pm).
- [8] Mulyati & Yulianti, T. (2012). Implementasi Program Perencanaan dan Pencegahan Komplikasi dengan Deteksi Dini Ibu Hamil Resiko Tinggi. *Midwifery Journal*, Vol.IV, NO.02
- [9] Prasetyawati, AE. (2012) Kesehatan Ibu dan Anak dalam Millenium Development goals (MDGs). Cetakan Pertama. Yogyakarta. Nuha Medika

- [10] Mikkelsen B. (2001). Metode Penelitian Partisipatoris dan Upaya-Upaya Pemberdayaan. Jakarta. Yayasan Obor Indonesia
- [11] Wafi, Nur and Mulihatun. (2010). Asuhan Fitramaya. Yogyakarta
- [12] Koch, T., & Kralik, D. (2006) Participatory Action research in Health Care Blackwell Publishing
- [13] Haines, A., (2009) Assets-based Community Development in an Introduction to Community Development. Rhonda Philips and Roberth H. Pitmann, 1st Ed. Roudledge, NY, USA.
- [14] Morgan A, Ziglio E. (2007). Revitalising the evidence base for public health : an assets odels. Promotion and Education 14:17
- [15] Creswell, J. W. (2013). Research design: Qualitative, quantitative, and mixed methods approaches: Sage publications.
- [16] Scrimshaw, S. C., & Hurtado, E. (1987). Rapid Assessment Procedures For Nutrition And Primary Health Care. Anthropological Approaches To Improving Programme Effectiveness.
- [17] Brikci, N., & Green, J., (2007) A Guide to Using Qualitative Research Methodology: Médecins sans Frontières.
- [18] Wibowo, A. (2014). Metodologi Penelitian Praktis Bidang Kesehatan. Jakarta: PT. Raja Grafindo Persada.
- [19] Creswell, J. (2010). Research Design. Pendekatan Kualitatif, Kuantitatif dan Mixed. Edisi Ketiga. Yogyakarta: Pustaka Pelajar.
- [20] Ghony, M., & Almanshur, F. (2012). Metodologi Penelitian Kualitatif. Sleman: Ar-Ruzz Media.
- [21] Katz, D., Elmore, J., Wild, D., & Lucan, S. (2014). Jekel's: epidemiology, biostatistics, preventive medicine and public health. Fourth edition. Philadelphia: Elsevier Saunders.
- [22] Harris, A. D., McGregor, J. C., Perencevich, E. N., Furuno, J. P., Zhu, J., Peterson, D. E., & Finkelstein, J. (2006). The Use and Interpretation of Quasi-Experimental Studies in Medical Informatics. Journal of the American Medical Informatics Association: JAMIA, 13(1), 16-23. doi: 10.1197/jamia.M1749
- [23] Melani, A. (2013). Studi kualitatif pengambilan keputusan dalam keluarga terkait dengan komplikasi perinatal di kabupaten Cianjur Jawa Barat. Medical Journal of Brawijaya University, 24(3).
- [24] Manandhar, D. S., Osrin, D., Shrestha, B. P., Mesko, N., Morrison, J., Tambahangphe, K. M., . . . Thapa, B. (2004). Effect of a participatory intervention with women's groups on birth outcomes in Nepal: cluster-randomised controlled trial. The Lancet, 364(9438), 970-979.
- [25] Tripathy, P., Nair, N., Barnett, S., Mahapatra, R., Borghi, J., Rath, S., . . . Sinha, R. (2010). Effect of a participatory intervention with women's groups on birth outcomes and maternal depression in Jharkhand and Orissa, India: a cluster-randomised controlled trial. The Lancet, 375(9721), 1182-1192.
- [26] Rifkin, S. B. (2009). Lessons from community participation in health programmes: a review of the post Alma-Ata experience. International Health, 1(1), 31-36.
- [27] Marston, C., Renedo, A., McGowan, C., & Portela, A. (2013). Effects of community participation on improving uptake of skilled care for maternal and newborn health: a systematic review. PloS one, 8(2), e55012.

- [28] O'Rourke, K., Howard-Grabman, L., & Seoane, G. (1998). Impact of community organization of women on perinatal outcomes in rural Bolivia. *Revista Panamericana de Salud Pública*, 3(1), 9-14.
- [29] Firoz, T., Vidler, M., Makanga, P.T., Boene, H., Chiaú, R., Sevene, E., Magee, L.A., Dadelszen, P.V., Munguambe, K., & the CLIP Working Group (2016). Community perspectives on the determinants of maternal health in rural southern Mozambique: a qualitative study. *Reproductive health*, 13(2), 112.
- [30] Pfeiffer, C., & Rosemarie, M. (2013). Delivering at home or in a health facility? Health-seeking behaviour of women and the role of traditional birth attendants in Tanzania. *BMC Pregnancy Childbirth*, 13.
- [31] Hailu, D., & Berhe, H. (2014). Knowledge about obstetric danger signs and associated factors among mothers in Tsegedie District, Tigray Region, Ethiopia 2013: community based cross-sectional study. *PloS one*, 9(2), e83459.
- [32] Lam, C., & Wong, S. (2002). Risk factors for preterm delivery in women with placenta praevia and antepartum haemorrhage: retrospective study. *Hong Kong medical journal= Xianggang yi xue za zhi/Hong Kong Academy of Medicine*, 8(3), 163-166.
- [33] Gilmore, B., & McAuliffe, E. (2013). Effectiveness of community health workers delivering preventive interventions for maternal and child health in low-and middle-income countries: a systematic review. *BMC Public Health*, 13(1), 1.
- [34] Crofts, J., Ellis, D., Draycott, T., Winter, C., Hunt, L., & Akande, V. (2007). Change in knowledge of midwives and obstetricians following obstetric emergency training: a randomised controlled trial of local hospital, simulation centre and teamwork training. *BJOG: An International Journal of Obstetrics & Gynaecology*, 114(12), 1534-1541.
- [35] Mbalinda, S. N., Nakimuli, A., Kakaire, O., Osinde, M. O., Kakande, N., & Kaye, D. K. (2014). Does knowledge of danger signs of pregnancy predict birth preparedness? A critique of the evidence from women admitted with pregnancy complications. *Health Research Policy and Systems*, 12(1), 1.
- [36] Graham, W., Themmen, E., Bassane, B., Meda, N., & De Brouwere, V. (2008). Evaluating skilled care at delivery in Burkina Faso: principles and practice. *Tropical Medicine & International Health*, 13(s1), 6-13.
- [37] Bloomfield, J., & Rising, S.S., (2013) CenteringParenting: An Innovative Dyad Model for Group Mother - Infant Care. *Journal of Midwifery & Women' s Health*, 58(6), 683-689.
- [38] Okour, A., Alkhateeb, M., & Amarin, Z. (2012). Awareness of danger signs and symptoms of pregnancy complication among women in Jordan. *International Journal of Gynecology & Obstetrics*, 118(1), 11-14.
- [39] Anya, S. E., Hydera, A., & Jaiteh, L. E. (2008). Antenatal care in The Gambia: missed opportunity for information, education and communication. *BMC Pregnancy and Childbirth*, 8(1), 1.
- [40] Rosenstein, M. G., Romero, M., & Ramos, S. (2008). Maternal mortality in Argentina: a closer look at women who die outside of the health system. *Maternal and child health journal*, 12(4), 519-524.
- [41] Nikiéma, B., Beninguise, G., & Haggerty, J. L. (2009). Providing information on pregnancy complications during antenatal visits: unmet educational needs in sub-Saharan Africa. *Health policy and planning*, 24(5), 367-376.

- [42] Pembe, A. B., Carlstedt, A., Urassa, D. P., Lindmark, G., Nyström, L., & Darj, E. (2010a). Effectiveness of maternal referral system in a rural setting: a case study from Rufiji district, Tanzania. *BMC health services research*, 10(1), 1.
- [43] Pembe, A. B., Carlstedt, A., Urassa, D. P., Lindmark, G., Nyström, L., & Darj, E. (2010b). Quality of antenatal care in rural Tanzania: counselling on pregnancy danger signs. *BMC Pregnancy and Childbirth*, 10(1), 1.
- [44] Notoatmodjo, S. (2007) *Promosi Kesehatan dan ilmu Perilaku*. Rineka Cipta Jakarta

Model Modification of Participatory of Community Asset Development Research In Action (YUDHIA) for Childbirth and Pregnancy

ORIGINALITY REPORT

10%

SIMILARITY INDEX

2%

INTERNET SOURCES

9%

PUBLICATIONS

1%

STUDENT PAPERS

PRIMARY SOURCES

- 1** Yudhia Fratidhina, Nursyirwan Effendi, Rizanda Machmud, Artha Budi Duarsa. "Basic Construction Factors of Participatory Asset Community Development Health In Action (Yudhia) Model to Prevent Complication of Pregnancy and Child-Birth", Jurnal Ilmu dan Teknologi Kesehatan, 2020
Publication 5%
- 2** "1st Annual Conference of Midwifery", Walter de Gruyter GmbH, 2020
Publication 3%
- 3** gupea.ub.gu.se
Internet Source 1%
- 4** health-policy-systems.biomedcentral.com
Internet Source 1%
- 5** Submitted to Universitas Brawijaya
Student Paper 1%

Exclude quotes On

Exclude bibliography On

Exclude matches < 1%